

Operator's Instruction Manual

Masonry Saws



BB14G

Shown with Optional Pro Cart



BB14E

Shown with Optional Stand

Gasoline and Electric 14" Masonry Saws



A Division of Equipment Development Company, Inc.

100 Thomas Johnson Drive, Frederick, MD 21702-4600 USA
Phone (301) 663-1600 • 1-800-638-3326
Fax (301) 663-1607 • 1-800-447-3326
Website: www.edcoinc.com
Email: sales@edcoinc.com

Printed in USA

trw ©2007

READ AND UNDERSTAND THE OPERATORS INSTRUCTION MANUAL *THOROUGHLY* BEFORE ATTEMPTING TO OPERATE THIS EQUIPMENT.



Death or serious injury could occur if this machine is used improperly.



SAFETY MESSAGES

- Safety Instructions are preceded by a graphic alert symbol of DANGER, WARNING, or CAUTION.



Indicates an imminent hazard which, if not avoided, will result in death or serious injury.



Indicates an imminent hazard which, if not avoided, can result in death or serious injury.



Indicates hazards which, if not avoided, could result in serious injury and or damage to the equipment.

GASOLINE POWERED EQUIPMENT



Engine exhaust from this product contains chemicals known to the State of California to cause cancer, birth defects or other reproductive harm.

- Do not operate gasoline powered equipment without adequate ventilation. Carbon monoxide is an invisible, odorless gas that can kill.



Gasoline is extremely flammable and poisonous. It should only be dispensed in well ventilated areas, and with a cool engine.

ELECTRICAL POWERED EQUIPMENT



Extreme care must be taken when operating electric models with water present: Ensure power cord is properly grounded, is attached to a Ground-Fault-Interrupter (GFI) outlet, and is undamaged.

- Check all electrical cables - be sure connections are tight and cable is continuous and in good condition. Be sure cable is correctly rated for both the operating current and voltage of this equipment.
- Improper connection of the equipment-grounding conductor can result in a risk of electric shock. Check with qualified electrician or service person if there is any doubt as to whether the outlet is properly grounded. Adhere to **all** local codes and ordinances.
- **NOTE:** In the event of a malfunction or breakdown, grounding provides a path of least resistance for the electric current to dissipate. The motor is equipped with a grounded plug and must be connected to an outlet that is properly installed and properly grounded. **DO NOT** modify the plug provided on the motor. If the plug does not fit the outlet have a qualified electrician install the proper receptacle.
- Switch motor OFF **before** disconnecting power.
- Do not disconnect power by pulling cord. To disconnect, grasp the plug, not the cord.
- Unplug power cord at the source and machine when not in use and before servicing.

GENERAL INSTRUCTIONS

- Equipment should only be operated by trained personnel in good physical condition and mental health (not fatigued). The operator and maintenance personnel must be physically able to handle the bulk weight and power of this equipment.
- This is a one person tool. Maintain a safe operating distance to other personnel. It is the **operators' responsibility** to keep other people (workers, pedestrians, bystanders, etc.) away during operation. Block off the work area in all directions with roping, safety netting, etc. for a safe distance. Failure to do so may result in others being injured by flying debris or exposing them to harmful dust and noise.
- This equipment is intended for commercial use only.
- For the operator's safety and the safety of others, always keep all guards in place during operation.
- Never let equipment run unattended.



- Personal Protection Equipment and proper safety attire must be worn when operating this machinery. The operator must wear approved safety equipment appropriate for the job such as hard hat and safety shoes when conditions require. Hearing protection **MUST** be used (operational noise levels of this equipment may exceed 90db). Eye protection **MUST** be worn at all times.



Keep body parts and loose clothing away from moving parts. Failure to do so could result in dismemberment or death.

- Do not modify the machine.

- Stop motor/engine when adjusting or servicing this equipment.



Maintain a safe operating distance from flammable materials. Sparks from the cutting-action of this machine can ignite flammable materials or vapors.

DUST WARNING



Some dust created by power sanding, sawing, grinding, drilling, and other construction activities contains chemicals known to cause cancer, birth defects, or other reproductive harm. Some examples of these chemicals are:

- Lead from lead-based paints, and
- Crystalline silica from bricks and concrete and other masonry products.

Your risk of exposure to these chemicals varies depending on how often you do this type of work. To reduce your risk: work in a well ventilated area, use a dust control system, such as an industrial-style vacuum, and wear approved personal safety equipment, such as a dust/particle respirator designed to filter out microscopic particles.

Operator's Instruction Manual

EDCO 14" Masonry Saws

Table of Contents

| <u>Section</u> | <u>Page Number</u> |
|----------------------------------|--------------------|
| Operator Controls | 4-5 |
| Safety Guidelines | 6 |
| Operating Instructions | 7-11 |
| Maintenance | 12-14 |
| Maintenance Schedule | 15 |
| Limited Equipment Warranty | back page |

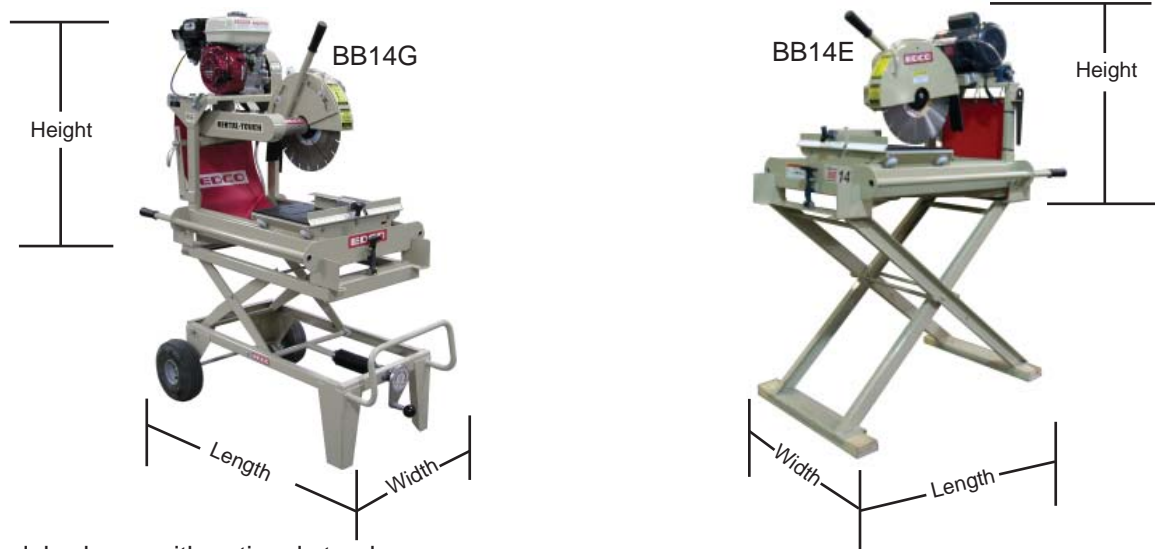

Both models shown with optional stands

Figure 1

| Specifications and dimensions are approximate and subject to change. | | |
|---|--------------------|-------------------|
| <p>HOW TO ORDER REPAIR PARTS</p> <p>To insure product safety and reliability, always use genuine EDCO replacement parts when making repairs to the equipment.</p> <p>When ordering parts, please specify the MODEL and SERIAL NUMBER of the machine as given on the NAMEPLATE. In addition, give part number, description and quantity as listed in the parts list.</p> <p>Please note: Due to improvements and changes in the equipment the illustrations shown may be different from the actual machine.</p> <p style="text-align: center;">Toll Free: Voice 1-800-638-3326 Fax 1-800-447-3326</p> | | |
| Model | BB14E | BB14G |
| Height | 31.5" 80cm | 37" 94cm |
| Width | 25" 63.5cm | 25" 63.5cm |
| Length | 42 1/4" 107.8cm | 43" 109cm |
| Weight | 165 lbs 74.8kg | 175 lbs 79.4kg |



A Division of Equipment Development Company, Inc.

100 Thomas Johnson Drive, Frederick, MD 21702-4600 USA
 Phone (301) 663-1600 • 1-800-638-3326
 Fax (301) 663-1607 • 1-800-447-3326
 Website: www.edcoinc.com
 Email: sales@edcoinc.com

Printed in USA

©2007

Page 3

Operator Controls - Gas Models

BB14 Gas (Figure 2)

- A. Air Filter
- B. Fuel Tank
- C. On/Off Switch
- D. Water Pump Belt Guard
- E. Oil Dip Stick
- F. Handle
- G. Blade Guard
- H. Water Tray Plug
- I. Rolling Table
- J. Angle Cutting Stop
- K. Welded Steel Frame/Water Tray
- L. Drive Belt Guard
- M. Cutting Head Lock
- N. Engine Throttle
- O. Recoil Starter
- P. Optional Pro Cart

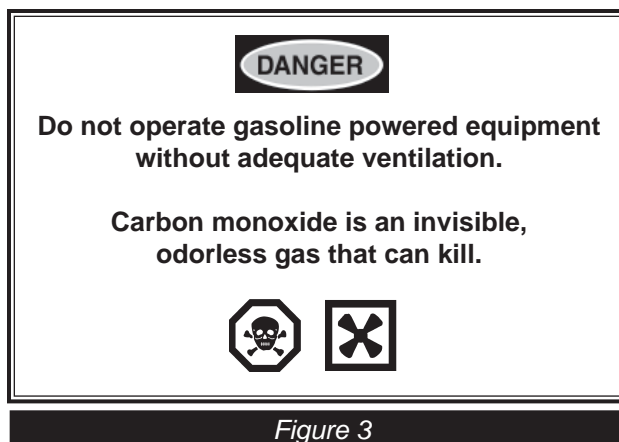
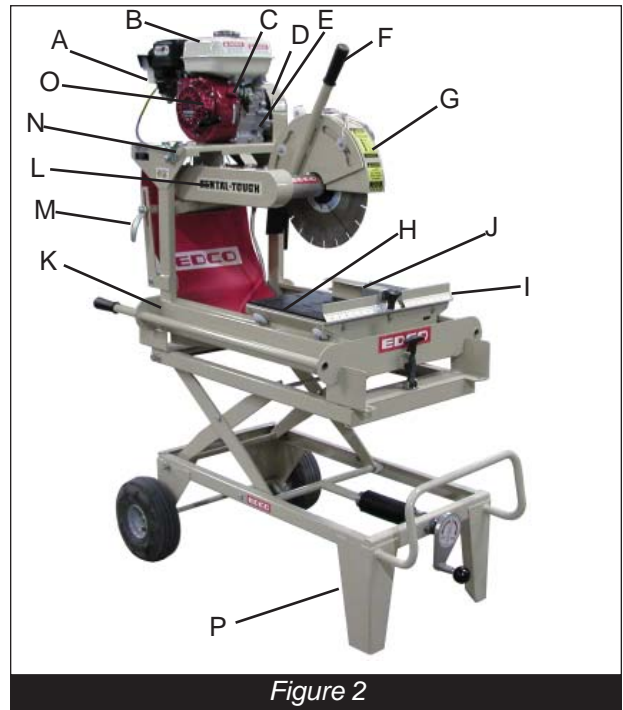

Operator Controls- Electric Models

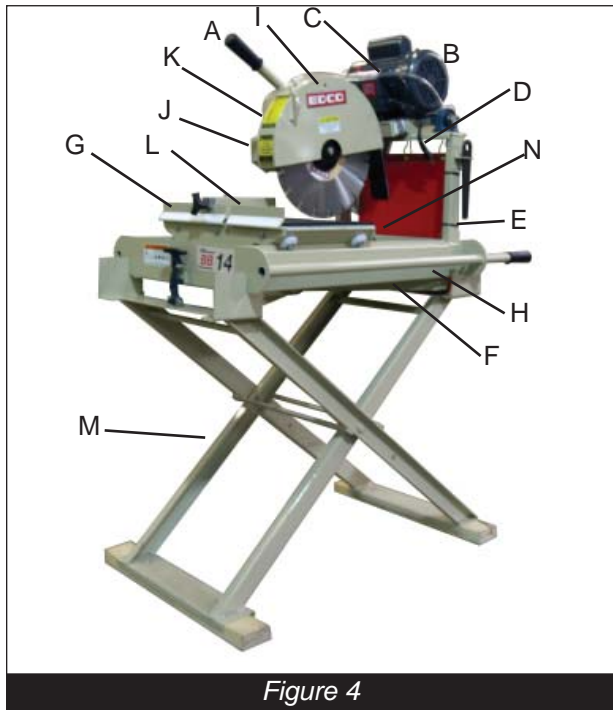

BB14 Electric (Figure 4)

- A. Operating Handle
- B. Motor
- C. Reset Button
- D. Power Cord
- E. Water Pick Up Hose
- F. Water Tray Plug
- G. Rolling Table
- H. Welded Steel Frame/Water Tray
- I. Blade Guard
- J. Drive Belt Guard
- K. Blade Guard Lock
- L. Cutting Angle Lock
- M. Optional Folding Table
- N. Submersible Water Pump

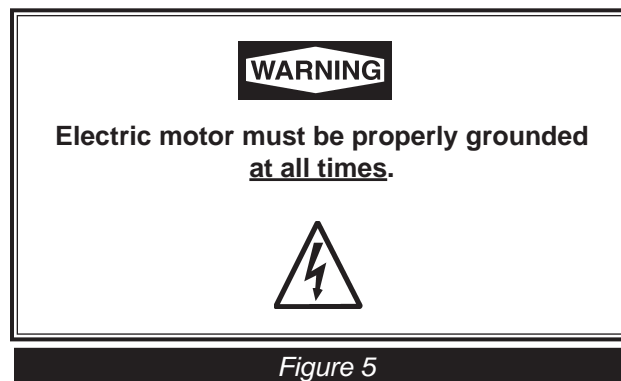

Figure 5



Read and understand this *Operator's Instruction Manual*,
and the *Engine Manufacturer's Owner's Manual*
before operating this equipment.
Death of serious injury can result if this machine is used improperly.



Safety Guidelines



Eye and ear protection must be worn at all times while the saw is in use. During normal operation, sound pressure levels exceed 92dBA. Use only ANSI approved safety glasses to help prevent eye injury. Standard eyeglasses have only impact resistant lenses; they are NOT safety glasses.



Operator must wear appropriate clothing and footwear. Do not wear loose clothing or jewelry that can get tangled in moving parts. Footwear should provide sure footing and protection from debris that may be dropped. Take steps to insure hair will not be caught in moving parts. If necessary, tie it back.

- When loading or unloading the saw, use caution. Make sure rolling table is locked so that the blade will not be damaged. Do not move the saw while the engine is running.
- Never exceed the maximum operating speed of the blade. Match the blade speed rating with the arbor shaft speed. (See page 11)
- Never leave the saw running unattended.
- Never operate this saw under the influence of drugs, alcohol or when taking medications that impair the senses or reactions, or when excessively tired or under stress.
- Do not lend or rent this equipment without including the Operator's Instruction Manual and the Engine Manufacturer's Manual.
- Make sure all safety decals can be clearly read and understood. Replace damaged or missing decals immediately.

For Electric Models:

- Electric motor must be properly grounded at all times. Check the outlet box to be sure the electrical service is properly grounded and that adequate power is available. Insufficient power will cause motor to overheat and burn out. Use only grounded extension cords correctly sized for the current draw and voltage drop (amp rating and length). Never use frayed, damaged, taped or under rated extension cords. Electrical shock could result in death or serious injury and damage to the equipment.

For Gasoline Models:

- Poisonous exhaust gas. Do not operate gasoline powered equipment without adequate ventilation. Carbon monoxide is an invisible, odorless gas that can kill. **NEVER REFUEL AN ENGINE WHILE IT IS HOT OR AN ENGINE WHILE IT IS RUNNING.** Only refuel in a well-ventilated area and only refuel after the engine has cooled completely. Thoroughly cleanup any spilled fuel before starting the engine.

Dry cutting creates a large volume of airborne dust. For health reasons, the operator should wear an applicable respirator. The dust may contain chemicals known to cause serious illnesses, including Silicosis - a fatal disease of the lungs. Check the chemical properties of the material to be cut and follow all EPA/OSHA regulations.



Safety warnings and guidelines do not by themselves eliminate danger.
They are not substitutes for proper accident prevention procedures and good judgement.

Operating Instructions

Before Starting:

- **Read and understand the instructions supplied by the engine manufacturer.**
- Familiarize yourself with all engine and saw controls. (Figure 2)
- Visually inspect the entire machine for damage or wear. Look for signs of oil or fuel leaks. Remove excess dirt or debris. Check that all nuts, bolts and screws are tight. Check for proper alignment of moving parts, possible binding of moving parts, breakage of parts, loose mounting brackets, and any other condition that might affect operation.
- Inspect diamond blade and arbor shaft. Check blades for cracks, loose segments, worn or out-of-round arbor holes. Do not use warped, twisted, out-of-balance blades or any blade of questionable condition. Refer to *Rx for Diamond Blades*.
- Install back splash shield (Figure 6 and 7).



Figure 6



Figure 7

On Gasoline Models:

- Gasoline models are shipped from the factory dry, meaning without oil or gasoline. Both will need to be added before the unit is used. Check the *Engine Manufacturer's Owner's Manual* for instructions on break-in, servicing and proper use of engine.
- Check engine oil. Make sure that it is at the proper level and that it is clean.
Note: Some engines have an Oil Alert System that will automatically stop the engine before the oil level falls below the safe limit. To avoid an unexpected shut down, check the oil level regularly during operation.
- Check the fuel level. Do not over fill fuel tank and **never refuel a hot engine**. If refueling is necessary during operation, allow engine to cool down first.

On Electric Models:

- Electric masonry saws are shipped with a grounded, male plug attached to the machine. Verify that any extension cord that is used is sized appropriately for the electrical load and that it is properly grounded. Use only 3 wire (single phase), grounded electrical cables that are marked U.L. and/or C.S.A. approved.



- Inspect the power and extension cords for damage. Do not use if either cord is frayed or showing signs of wear.
- Identify the electrical power requirements of the saw. The voltage requirements of the motor can be found on the motor data plate.
- Verify that the power switch is in the off position before plugging machine into the power source.



A Division of Equipment Development Company, Inc.

100 Thomas Johnson Drive, Frederick, MD 21702-4600 USA
 Phone (301) 663-1600 • 1-800-638-3326
 Fax (301) 663-1607 • 1-800-447-3326
 Website: www.edcoinc.com
 Email: sales@edcoinc.com

Printed in USA

TMW ©2007

Page 7

When Wet Cutting:

- Secure the drain plug and fill the tray with clean water.

On Gasoline Models:

- To engage water pump loosen the black knob and push top of water pump to the left with constant pressure and tighten black knob. (Figure 9 & 12)
- Prime the pump using the priming bulb. Pump the bulb until water fills the clear plastic coolant hose from the tray to the pump.

On Electric Models:

- Plug submersible pump into the special outlet on the motor (circled). (Figure 10)

CAUTION This outlet is intended for the water pump only pictured in (Figure 11). Do not use it for any other purpose.



- To engage water pump loosen the black knob and push top of water pump to the left with constant pressure and tighten black knob. (Figures 9 & 12) Use the priming bulb shown in (Figure 13) to prime the water pump.

CAUTION DO NOT LET THE WATER PUMP RUN DRY.

On All Models:

- The water in the tray must be kept clean. Running dirty water through the system will cause damage.
- To change the water, turn off the saw, remove the plug in the bottom of the tray to drain water and dispose of properly. Do not drain onto the surface being worked on or other maintained surface because staining will occur. Flush any loose grit and dirt out of the tray. Replace drain plug and refill with clean water. If water flow to the blade seems to be low, check that strainer is clean and the water pump pulley is properly engaged.

When Dry Cutting:

- Drain and flush any water or debris in the tray and dispose of properly.

On Gasoline models:

- To disengage water pump loosen the black knob and push top of water pump to the right with constant pressure and tighten black knob. (Figures 9 & 12)

On Electric Models:

- Unplug the submersible pump from the water pump outlet on the motor.

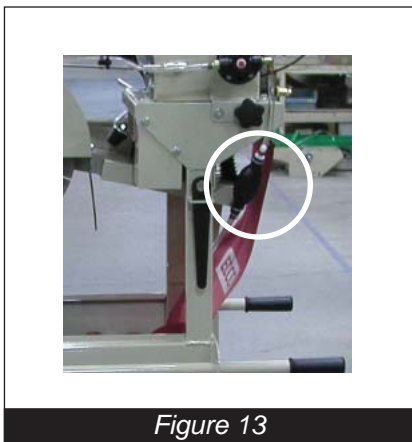

Figure 13



Figure 12

- To disengage water pump loosen the black knob and push top of water pump to the right with constant pressure and tighten black knob (Figures 9 & 12).

CAUTION**DO NOT LET THE WATER PUMP RUN DRY.****WARNING**

Be careful when draining water from tray and dispose of waste away from work area.

Draining the water directly to the ground will cause a potentially serious working hazard including, but not limited to, risk from electric shock if using an electric motor.

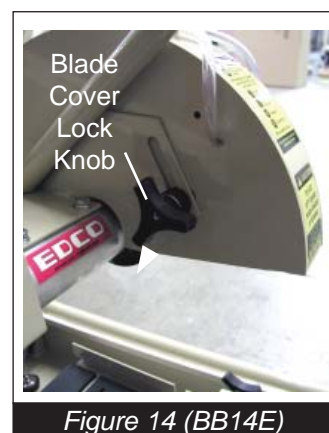

Figure 14 (BB14E)

Starting the Engine:

- Be sure blade is clear of item to be cut.
- Determine that the recoil starter assembly turns freely, starter rope pulls easily, and the rope retracts properly.
- Follow the instructions supplied in the *Engine Manufacturer's Owner's Manual* for starting engine.
- Open the throttle and allow engine to reach operating temperature. Open throttle fully, do not use the throttle as a means to match the arbor shaft speed to the specified blade speed requirements.
Be certain to use the proper blade for the machine.

Note: To ensure that the necessary power is transferred to the blade, all cutting must be done at *full throttle*. The governor is factory set for correct speed - altering this setting may damage the machine. Maintain the engine according to factory specifications.



Starting the Electric Motor:

REMINDER: Motor burnout due to use of improper voltage will void the warranty on the motor.

- Be sure blade is clear of the item to be cut.
- Turn on the motor.
- Listen for motor to reach operating speed. Do not use if motor hums or does not reach operating speed within a few seconds. Motor hum may indicate a malfunction due to:
 - Job site voltage may too low.
 - An Internal motor problem.
 - The blade may be jammed.or
 - The belts may be too tight.

Cutting:

- Do not strain the engine/motor while cutting. Do not jam work piece into the blade. Do not twist the work piece while cutting.
- When you have finished cutting:

On Gasoline models: To stop engine, return throttle to idle. Stop the engine by turning the engine mounted stop switch to the OFF position. Do not leave the saw running unattended.

On electric models: Turn the power switch to OFF. Wait until saw comes to a complete stop before performing any type maintenance.

- Clean dust and debris from machine.

IMPORTANT:

- When actually cutting masonry products, it is important that the blade is at it's maximum RPM. DO NOT force or jam the blade. Forcing the blade will cause the motor to overheat, tripping the overload device or severe motor damage.



- Do not reach underneath or around work piece while the blade is rotating.
- Keep stable footing at all times while cutting.
- Keep hair, clothing, fingers and all body parts away from the blade and any other moving parts.



| Model | Diameter Blade | Arbor Shaft Rating | Max. Cutting Depth |
|-------|----------------|--------------------|--------------------|
| BB14E | 14 inches | 2600 RPM | 5 inches |
| BB14G | 14 inches | 2600 RPM | 5 inches |

Figure 17

Possible Diamond Blade Problems

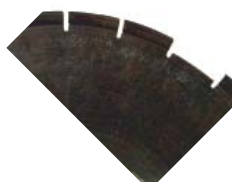

Segment Loss:
Usually insufficient water

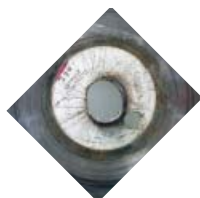

Arbor Hole Out-Of-Round
Blade not properly tightened or seated on arbor.



Cracked Segments and/or Core
Wrong Blade for the job.

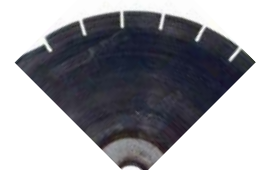

Blade Will Not Cut:
Blade is glazed or too hard for the job.



Disconnect spark plug lead before performing any maintenance on this machine.



Maintenance

Consult the *Engine Manufacturer's Owner's Manual* for more detailed engine maintenance instructions.

Changing the Blade:

- Inspect the new blade thoroughly before installing. Check for cracks, loose or missing segments, worn or out-of-round arbor holes. Refer to the *Rx for Diamond Blades* pamphlet provided with your blade for more detailed information on inspecting blades. Be sure the blade is appropriate for the job and matches the arbor speed and mounting configuration on this saw. (Figure 17)



Figure 18

- Push the rolling table all the way to the back of the machine.
- Blade guard should be rotated all the way up and tightened into place.
- Remove blade cap and bolt. Carefully remove old blade.
- Inspect arbor shaft, backing plate and blade guard while blade is off. Clean if dirty or replace if damaged or worn.
- Look for "direction of rotation" markings on the blade. (Usually an arrow stamped on the blade.)
- Place new blade on the arbor shaft verifying that once installed the markings on the blade follow the proper direction of rotation.
- Reinstall and tighten bolt using a SAE 3/4" wrench. Reinstall blade cap.
- Reposition blade guard and tighten. Reconnect spark plug lead. (if applicable)

Belt Adjustment and Replacement:

- Periodically check belt(s) for damage, same type and are at the proper tension. Do not mix belts. Slipping belt(s) will overheat causing the cutting speed to be limited and shorten the life of the belts. Over-tensioned belts will shorten the life of the belt(s) and bearings.
- On new equipment and after installing new belt(s) of the same type, be certain to re-tension the belt(s) after the first 4 hours of use. New belts are stiff and require a break in period. Belts that are loose could slip and/or over-heat.
- Damaged, stretched or excessively worn belt(s) should be replaced with a new complete set of belt(s) of the same type. Do not mix belts.

Important!

- **Belt(s) must be replaced with the same type.**
- **Blade must be realigned every time the belt(s) are tensioned, gas model only.**

On Gasoline Models:

- Access belt from back of machine.
- Remove two (2) cap screws from both sides of the belt guard as circled in photo to right (*Figure 19*). Lift off belt cover, Water pump drive wheel and belt are now accessible.
- To change drive belt, loosen engine mount bolts and belt tensioner, tilt engine toward water pump until belt can be removed.



Figure 19

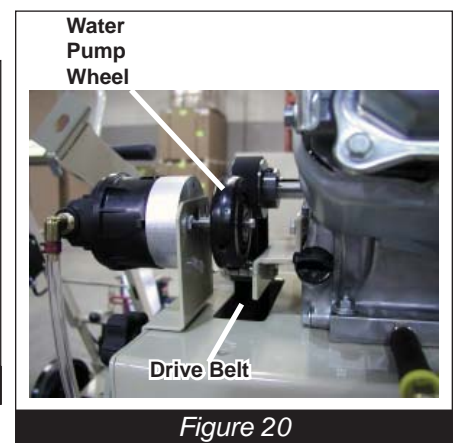

Figure 20

On Electric Models:

NOTE: Due to machine improvements pictures may not show your particular machine. The instructions however are the same.

- Loosen motor mounts (4) (*Figure 21*)
- Loosen jacking bolt until belts slide off sheave. (*Figure 22*)
- Replace with a new complete set of belts of same type. Do not mix belt types.
- Adjust jacking bolt to tension belts.
- Square motor to frame.
- Retighten motor mount bolts.

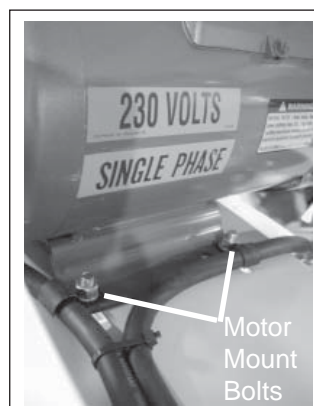

Figure 21

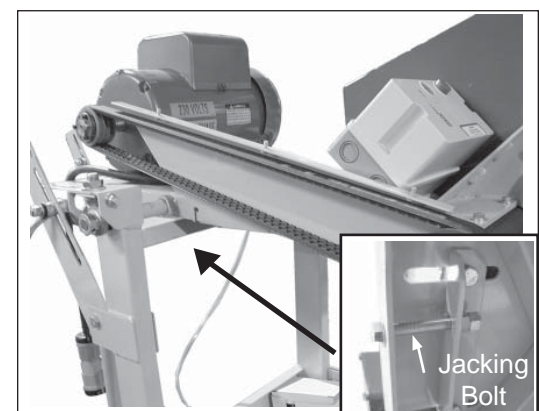

Figure 22



A Division of Equipment Development Company, Inc.

100 Thomas Johnson Drive, Frederick, MD 21702-4600 USA
 Phone (301) 663-1600 • 1-800-638-3326
 Fax (301) 663-1607 • 1-800-447-3326
 Website: www.edcoinc.com
 Email: sales@edcoinc.com

Printed in USA

trw ©2007

Page 13

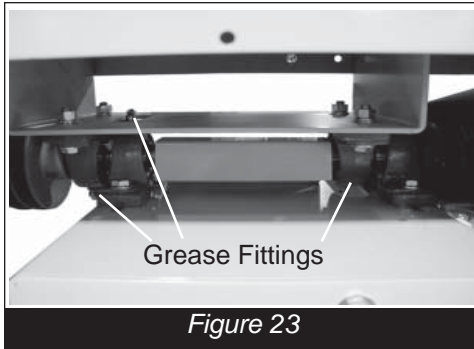

Grease Bearings:

- Drive shaft bearings must be greased every 4 hours. (All are not visible in this photo)

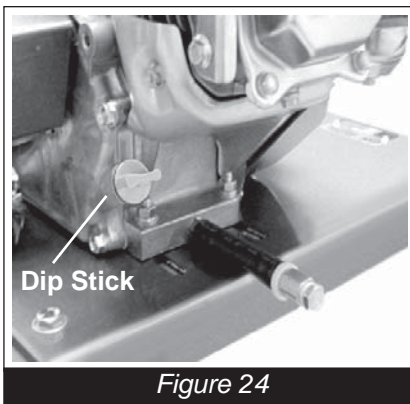

Change Engine Oil:

- Check Engine Oil before each operation. Open the filler cap and look at the dip stick. (Figure 24) Oil should be clearly visible both on the stick and in the cavity and should look fairly clean. Running the machine on dirty oil or when the oil is low will result in damage to the engine.
- Change the Engine Oil after every 50 hours of operation or sooner as conditions require. Refer to the Engine Manufacturer's Owner's Manual for specific viscosity recommendations and changing instructions.



Inspect and Clean Air Filter:

(Figure 25 shows Honda Cyclone Dual Filter style element).

- Refer to the Engine Manufacturer's Owner's Manual for instructions on specific models.
- Check air filter *at least* once daily.
- Dirt build up on the filter will cause excessive engine wear.

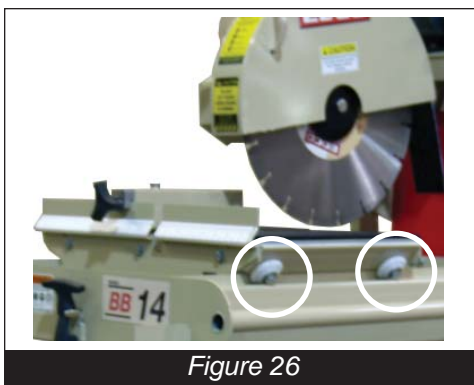

Clean and Lubricate Wheels on Rolling Table:

- During daily visual inspection, check to be sure the wheels on both sides of the rolling table move smoothly and that there is no debris in the wheel groove. (Circled) (Figure 26)
- Lubricate the wheels as necessary.
- Replace damaged or worn wheels.



Repairs are to be preformed by EDCO or by approved EDCO repair technicians.



Read and follow all instructions in the Engine Manufacturer's Owner's Manual.

Maintenance Schedule

| | Before each Operation | Daily | Every 4 Hours | Every 50 Hours of Operation | As Required | Annually |
|--|-----------------------|-------|---------------|-----------------------------|-------------|----------|
| Visually Inspect Entire Machine and Hardware | X | | | | | |
| Check Engine Oil* | X | | | | | |
| Inspect Blade and Arbor Shaft | X | | | | | |
| Inspect Guards | | X | | | | |
| Clean Air Filter Element* | | X | | | | |
| Clean Dust and Dirt Off Machine | | X | | | | |
| Change Engine Oil* | | | | X | | |
| Inspect Belts | | | | | X | |
| Belt Tensioning | | | | | X | |
| Lubricate Wheels on Rolling Table | | | | | X | |
| Replace Spark Plug* | | | | | | X |
| Clean Water Strainer | | X | | | | |
| Grease Bearings | | | X | | | |

*Gasoline Models Only



A Division of Equipment Development Company, Inc.

100 Thomas Johnson Drive, Frederick, MD 21702-4600 USA
 Phone (301) 663-1600 • 1-800-638-3326
 Fax (301) 663-1607 • 1-800-447-3326
 Website: www.edcoinc.com
 Email: sales@edcoinc.com

Printed in USA

©2007

Page 15

LIMITED EQUIPMENT WARRANTY OF SALE – TERMS & CONDITIONS

Equipment Development Company, Inc. herein referred to as EDCO (Seller) warrants that each new unit manufactured by EDCO to be free from defects in material and workmanship in normal use and service for a period of (1) one year (except for the cutter drum assembly on all model concrete/asphalt planes, in which case the warranty period shall be 90 days) from date of shipment to the original retail or equipment rental center owner.

Accessories or equipment furnished and installed on the product by EDCO but manufactured by others, including, but not limited to engines, motors, electrical components, transmissions etc., shall carry the accessory manufacturers own warranty.

EDCO will, at its option, repair or replace, at the EDCO factory or at a point designated by EDCO, any part which shall appear to the satisfaction of EDCO inspection to have been defective in material or workmanship.

EDCO reserves the right to modify, alter and improve any part or parts without incurring any obligation to replace any part or parts previously sold without such modified, altered or improved part or parts.

This warranty is in lieu of and excludes all other warranties, expressed, implied, statutory, or otherwise created under applicable law including, but not limited to the warranty of merchantability and the warranty of fitness for a particular purpose in no event shall seller or the manufacturer of the product be liable for special, incidental, or consequential damages, including loss of profits, whether or not caused by or resulting from the negligence of seller and/or the manufacturer of the product unless specifically provided herein. In addition, this warranty shall not apply to any products or portions thereof which have been subjected to abuse, misuse, improper installation, maintenance, or operation, electrical failure or abnormal conditions and to products which have been tampered with, altered, modified, repaired, reworked by anyone not approved by seller or used in any manner inconsistent with the provisions of the above or any instructions or specifications provided with or for the product

FORCE MAJEURE

Seller's obligation hereunder are subject to, and Seller shall not be held responsible for, any delay or failure to make delivery of all or any part of the Product due to labor difficulties, fires, casualties, accidents, acts of the elements, acts of God, transportation difficulties, delays by a common carrier, inability to obtain Product, materials or components or qualified labor sufficient to timely perform part of or all of the obligations contained in these terms and conditions, governmental regulations or actions, strikes, damage to or destruction in whole or part of manufacturing plant, riots, terrorist attacks or incidents, civil commotions, warlike conditions, flood, tidal waves, typhoon, hurricane, earthquake, lightning, explosion or any other causes, contingencies or circumstances within or without the United States not subject to the Seller's control which prevent or hinder the manufacture or delivery of the Products or make the fulfillment of these terms and conditions impracticable. In the event of the occurrence of any of the foregoing, at the option of Seller, Seller shall be excused from the performance under these Terms and Conditions, or the performance of the Seller shall be correspondingly extended.

This document sets forth the terms and conditions pursuant to which the purchaser ("Purchaser") will purchase and Equipment Development Co. Inc. ("Seller") will sell the products, accessories, attachments (collectively the Products) ordered by the Purchaser. These terms and conditions shall govern and apply to the sale of Seller's Products to Purchaser, regardless of any terms and conditions appearing on any purchase order or other forms submitted by Purchaser to Seller, or the inconsistency of any terms therein and herein.

1. PRICE

All prices set forth on any purchase order or other document are F.O.B. Sellers facility or distribution point, as may be determined by Seller (F.O.B. Point). All prices are exclusive of any and all taxes, including, but not limited to, excise, sales, use, property or transportation taxes related to the sale or use of the Products, now or hereafter imposed, together with all penalties and expenses. Purchaser shall be responsible for collecting and/or paying any and all such taxes, whether or not they are stated in any invoice for the Products. Unless otherwise specified herein, all prices are exclusive of inland transportation, freight, insurance and other costs and expenses relating to the shipment of the Products from the F.O.B. point to Purchaser's facility. Any prepayment by Seller of freight insurance and other costs shall be for the account of Purchaser and shall be repaid to Seller.

2. PAYMENT TERMS

Payment terms are as follows. 2% 10 days (to approved and qualified accounts). Net 30 days. This is a cash discount for invoices paid within 10 days after the invoice date, regardless of date of receipt of shipment. This is not a trade discount and will not be granted to accounts that do not adhere to stated terms.

*All past due accounts are subject to a late payment fee of 1.5% per month or a maximum allowed by law if different, along with the expenses incidental to collection including reasonable attorney's fees and costs.

*Seller reserves the right to hold shipments against past due accounts.

*Seller reserves the right to alter payment terms.

3. FREIGHT TERMS

All shipments will be made F.O.B. shipping point as designated in these Terms and Conditions, and title shall pass at the F.O.B. point. Delivery to the initial common carrier shall constitute delivery to the Purchaser. Any claims for loss or damage during shipment are to be filed with carrier by the Purchaser. Seller will not assume responsibility for the performance of the carrier.

Back orders will be shipped in the most practical fashion with charges consistent with our freight policy established with the original order. UPS, FED EX, MAIL or shipments by other couriers are subject to the same terms and conditions as outlined in paragraph #3 "Freight Terms".

4. DELIVERY, DAMAGES, SHORTAGES

Seller shall use reasonable efforts to attempt to cause the Products to be delivered as provided for in these Terms & Conditions. Delivery to the initial common carrier shall constitute the delivery to the Purchaser. Seller's responsibility, in so far as transportation risks are concerned ceases upon the delivery of the Products in good condition to such carrier at the F.O.B. point and all the Products shall be shipped at the Purchaser's risk. Seller shall not be responsible or liable for any loss of income and/or profits, or incidental, special, consequential damages resulting from Seller's delayed performance in shipment and delivery.

5. RETURN OF DEFECTIVE PRODUCTS

Defective or failed material shall be held at the Purchaser's premises until authorization has been granted by Seller to return or dispose of Products. Products that are to be returned for final inspection must be returned Freight Prepaid in the most economical way. Credit will be issued for material found to be defective upon Seller's inspection based on prices at time of purchase.

6. PRODUCTS ORDERED IN ERROR

Products may be returned, provided that claim is made and Seller is notified within 7 days of receipt of Products, and the Products are in original buyer's possession not more than 30 days prior to return, subject to Seller's approval. If Products are accepted for return, they must be Freight Prepaid and buyer will be charged a minimum of 15% rehandling charge, plus a charge back for outbound freight charges if the original order was shipped prepaid. Returns are not accepted for any Products that are specifically manufactured to meet the buyer's requirement of either specifications or quantity.

AGREEMENTS

These Terms and Conditions constitute the entire agreement between Seller and Purchaser as it relates to terms and conditions of sale, and supersedes any and all prior oral or written agreements, correspondence, quotations or understandings heretofore in force between the parties relating to the subject matter hereof. There are no agreements between Seller and Purchaser with respect to the Product herein except those specifically set forth in and made part of these terms and conditions. Any additional terms, conditions and/or prices are rejected by Seller.

These terms and conditions may be modified, cancelled or rescinded only by a written agreement of both parties executed by their duly authorized agents.

USE ONLY GENUINE EDCO PARTS & ACCESSORIES
For your own safety, the safety of others and the life of your machine.